



Yes, you can.®



Invacare® Dragon Vertic

*Power wheelchair
User manual*



How can you get in touch with Invacare®?

If you have any questions or need support, please contact your authorised Invacare® Dealer, who has the necessary know-how and equipment plus the special knowledge concerning your Invacare® product, and can offer you all-round satisfactory service. Should you wish to contact Invacare® directly, you can reach us in Europe at the following addresses and phone numbers.

A	Invacare Austria GmbH Herzog Odilostrasse 101 A-5310 Mondsee Austria	☎: Fax: @: WWW:	+43 6232 5 53 50 +43 6232 5 53 54 info@invacare-austria.com www.invacare.at
----------	--	--------------------------	--

B	Invacare n.v. Autobaan 22 B-8210 Loppem (Brugge)	☎: Fax: @: WWW:	+32 (0)50 83 10 10 +32 (0)50 83 10 11 belgium@invacare.com www.invacare.be
----------	---	--------------------------	---

CH	Invacare AG Benkenstraße 260 CH-4108 Witterswil Switzerland	☎: Fax: @: WWW:	+41 (0)61487 70 80 +41 (0)61487 70 81 switzerland@invacare.com www.invacare.ch
-----------	---	--------------------------	---

D	Invacare GmbH Alemannenstraße 10 88316 Isny Deutschland	☎: Fax: @: WWW:	+49 (0)7562 70 00 +49 (0)7562 7 00 66 kontakt@invacare.com www.invacare.de
----------	---	--------------------------	---

DK	Invacare A/S Sdr. Ringvej 37 DK-2605 Brøndby Danmark	☎ (Kundeservice): Fax (Kundeservice): @: WWW:	+45 (0)36 90 00 00 +45 (0)36 90 00 01 denmark@invacare.com www.invacare.dk
-----------	--	--	---

E	Invacare® SA c/ Areny s/n Polígon Industrial de Celrà E-17460 Celrà (Girona) ESPAÑA	☎: Fax: @: WWW:	+34 (0)972 49 32 00 +34 (0)972 49 32 20 contactsp@invacare.com www.invacare.es
----------	--	--------------------------	---

F	Invacare® Poirier SAS Route de St Roch F-37230 Fondettes France	☎: Fax: @: WWW:	+33 (0)247 62 64 66 +33 (0)247 42 12 24 contactfr@invacare.com www.invacare.fr
GB	Invacare® Ltd Pencoed Technology Park Pencoed Bridgend CF35 5AQ United Kingdom	☎ (Customer services): Fax (Customer services): @: WWW:	+44 (0)1656 77 62 22 +44 (0)1656 77 62 20 uk@invacare.com www.invacare.co.uk
I	Invacare Mecc San s.r.l. Via dei Pini, 62 I - 36016 Thiene (VI) ITALIA	☎: Fax: @: WWW:	+39 0445 38 00 59 +39 0445 38 00 34 italia@invacare.com www.invacare.it
IE	Invacare Ireland Ltd. Unit 5 Seatown Business Campus Seatown Rd, Swords County Dublin Ireland	☎: Fax: @: WWW:	+353 18 10 70 84 +353 18 10 70 85 ireland@invacare.com www.invacare.ie
N	Invacare® AS Grensesvingen 9 Postboks 6230 Etterstad N-0603 Oslo Norge	☎ (Kundeservice): Fax (Kundeservice): @: @: WWW:	+47 (0)22 57 95 00 +47 (0)22 57 95 01 norway@invacare.com island@invacare.com www.invacare.no
NL	Invacare® B.V. Celsiusstraat 46 NL-6716 BZ Ede Nederland	☎: Fax: @: @: WWW:	+31 (0)318 69 57 57 +31 (0)318 69 57 58 nederland@invacare.com csede@invacare.com www.invacare.nl
P	Invacare Lda Rua Estrada Velha, 949 P-4465-784 Leça do Balio Portugal	☎: ☎: Fax: @: WWW:	+351 225 10 59 46 +351 225 10 59 47 +351 225 10 57 39 portugal@invacare.com www.invacare.pt



Aterförsäljare:
Invacare® AB
 Fagerstagatan 9
 S-163 91 Spånga
Sverige

☎ (Kundtjänst): +46 (0)8 761 70 90
 Fax (Kundtjänst): +46 (0)8 761 81 08
 @: sweden@invacare.com
 @: finland@invacare.com
 WWW: www.invacare.se



Tillverkare:
Invacare® Deutschland GmbH
 Kleiststraße 49
 D-32457 Porta Westfalica
Deutschland

MÖLNDAL
 ☎: +46 (0)31 86 36 00
 Fax: +46 (0)31 86 36 06
 @: ginvacare@invacare.com

LANDSKRONA
 ☎: +46 (0)418 2 85 40
 Fax: +46 (0)418 1 80 89
 @: linvacare@invacare.com

OSKARSHAMN
 ☎: +46 (0)491 1 01 40
 Fax: +46 (0)491 1 01 80
 @: oinvacare@invacare.com

**Eastern
 european
 countries**

**European Distributor
 Organisation (EDO)**
 Kleiststraße 49
 D-32457 Porta Westfalica
Deutschland

☎ +49 (0)5731 75 45 40
 Fax +49 (0)5731 75 45 41
 @: edo@invacare.com
 WWW: www.invacare.de

Table of Contents

Chapter		Page
1	Introduction	10
	1.1 Important symbols in this manual	11
	1.2 Important symbols found on the vehicle	13
	1.3 Type classification and permissible use	16
	1.4 Indications.....	17
	1.5 Counter indications	18
	1.6 Usability	18
	1.7 Warranty	19
	1.8 Life expectancy.....	20
2	Safety notes	21
	2.1 General safety notes.....	21
	2.2 Safety information with regard to care and maintenance	24
	2.3 Safety information on electromagnetic interference	24
	2.4 Safety information on driving and freewheel mode	26
	2.5 Safety information regarding changes and modifications to the mobility device	28
	2.6 Safety information for the verticalizer	30
3	Key features	32
4	The position of the labels on the product	33
5	Getting in and out of the wheelchair	34
	5.1 Raise the parallel sliding armrest / remove the skirtguard (optional)	34
6	Driving	36
	6.1 Before driving for the first time.....	36
	6.2 Taking Obstacles	37
	6.2.1 Maximum obstacle height.....	37

	6.2.2	Safety information when ascending obstacles	37
	6.2.3	The correct way to overcome obstacles	38
	6.3	Driving up and down gradients	39
	6.4	Parking and stationary	40
	6.5	Use on public roads	40
7		Pushing the wheelchair in freewheel mode	41
	7.1	Disengaging Motors	41
8		Remotes	42
9		Adjusting the wheelchair to the user's seating posture	43
	9.1	Torques	44
	9.2	Adjusting the seat depth	44
	9.3	Legrest	48
	9.3.1	Setting the lower leg length of the legrest	48
	9.4	Changing the height of the backrest	50
	9.5	Restraining straps for the legs	55
	9.5.1	Opening and closing the restraining strap	55
	9.5.2	Adjusting the position of the release lever	57
	9.5.3	Adjusting the retaining bar and knee cushions	58
	9.5.3.1	Setting the depth of the restraining strap	58
	9.5.3.2	Adjusting the height of the knee cushions	59
	9.5.3.3	Setting the width of the knee cushions	61
	9.6	Posture belt for the legs	62
	9.6.1	Setting the knee cushion depth	62
	9.6.2	Setting the knee cushion height	64
	9.6.3	Attaching the knee cushion	65
	9.7	Adjusting the armrests and the control panel	67
	9.7.1	Adapting the height of the armrests	67
	9.7.2	Setting the angle of the swing-up armrest	68
	9.7.3	Setting the resistance of the swing-up armrest	69
	9.7.4	Adapting the control panel to the length of the user's arm	70

9.7.5	Setting the height of the remote	71
9.7.6	Adjusting the width of the armrests	72
9.8	Adapting the height of the chest belt	74
9.9	Adjusting the backrest	75
9.10	Adjusting the headrest	76
9.10.1	Adjusting the height	76
9.10.2	Setting the position	77
9.11	Adjustment of the stand-up angle	78
9.12	Postural belts	81
9.12.1	Types of postural belts.....	81
9.12.2	Adjusting the postural belt correctly.....	82
9.13	Adjusting the table (option).....	83
9.13.1	Swivelling the table upward	83
9.13.2	Adjusting the depth of the table	85
9.14	Operating the verticalizer.....	86
10	Electrical system	87
10.1	Electronics protection system	87
10.1.1	The main fuse	88
10.2	Batteries.....	89
10.2.1	Charging the batteries	89
10.2.1.1	General information on charging	89
10.2.1.2	General instructions on charging.....	89
10.2.1.3	How to charge the batteries.....	90
10.2.1.4	How to disconnect the batteries after charging	91
10.2.2	Storage and Maintenance.....	92
10.2.3	Instructions on using the batteries.....	92
10.2.4	Transporting batteries.....	94
10.2.5	Handling batteries.....	94
10.2.5.1	General instructions on handling the batteries	94
10.2.5.2	How to handle damaged batteries correctly	94
10.2.5.3	Removing the batteries.....	96

11	Care and maintenance	98
12	Repair instructions	101
	12.1 Repairing a flat tyre.....	101
	12.1.1 Repairing a flat tyre at the back (tyre type 3.00-8").....	102
13	Transport.....	105
	13.1 Transferring the wheelchair to a vehicle.....	105
	13.2 Securing the wheelchair for transport without passengers.....	106
14	Refurbishment	107
15	Disposal	107
16	Technical specifications	108
17	Inspections Performed.....	111

1 Introduction

Dear user,

First we would like to thank you for purchasing our product! We hope that you will have a great deal of pleasure with your new power wheelchair.

This operating manual contains important information and notes about:

- **Safety**
- **Operation**
- **Care and maintenance**

Please take care to read the operating manual thoroughly before starting out on your first journey.

This wheelchair has been constructed for a large circle of users with different requirements.

The decision whether the model is suitable for the user may only be taken by medical specialists with appropriate expertise.

Invacare® or their statutory representatives can accept no liability in cases in which the wheelchair has not been adapted to suit the users' handicaps.

Some maintenance and settings can be performed by the user or his/hers attendants. Certain adjustments do however require technical training and may only be carried out by your Invacare® specialist dealer. Damages and errors caused by nonobservance of the user manual or as a result of incorrect maintenance are excluded from all guarantees.

This manual contains copyrighted information. This manual may not be reproduced or reprinted either partly or completely without previous written consent from Invacare® or its statutory representatives. We reserve the right to make any necessary alterations on the grounds of technical improvements.

1.1 Important symbols in this manual



General risks

This symbol warns you of general hazards!

- *Always follow the instructions to avoid injury to the user or damage to the product.*
-



EXPLOSION HAZARD!

This symbol warns you of an explosion hazard, which can be caused by excessive tyre pressure in a pneumatic tyre.

- *Always follow the instructions to avoid injury to the user or damage to the product.*
-



BURN HAZARD!

This symbol warns you of the danger of chemical burns, for example due to the discharge of battery acids!

- *Always follow the instructions to avoid injury to the user or damage to the product.*
-



BURN Risk!

This symbol warns of the risk of burns, for example, as a result of hot motor surfaces.

- *Follow the instructions in order to avoid injury or damage to the product.*
-



RISK OF CRUSHING!

This symbol warns of a risk of crushing caused by being careless with heavy components.

- *Always follow the instructions to avoid injury to the user or damage to the product.*
-



Wear eye protection

This symbol refers to the requirement for wearing eye protection, for example when working with batteries.

- *You must wear safety goggles when this symbol is displayed.*
-



Wear protective gloves

This symbol indicates the requirement to wear protective gloves, for example when working with batteries.

You must wear protective gloves when this symbol is displayed.



NOTE:

This symbol identifies general information which is intended to simplify working with your product and which refers to special functions.



Requirements:

- This symbol identifies a list of various tools, components and items which you will need in order to carry out certain work. Please do not attempt to carry out the work if you do not have the listed tools available.
-



READ WELL BEFORE OPERATION!

This symbol advises you to read information carefully.

1.2 Important symbols found on the vehicle



DO NOT DRIVE OVER UNEVEN GROUND! Danger of tipping over!



DO NOT LEAN OUT OF THE RAISED VERTICALIZER! Danger of tipping over!



THE VERTICALIZER IS NOT DESIGNED TO TRANSPORT MORE THAN ONE SINGLE PERSON! Danger of injury!



NEVER DRIVE ON ASCENDING OR DOWNWARD SLOPES WHEN THE VERTICALIZER IS RAISED! Danger of tipping over!



NEVER REACH INTO THE MOVING APPARATUS OF THE RAISED VERTICALIZER! Danger of crushing!



This product has been supplied from an environmentally aware manufacturer. This product may contain substances that could be harmful to the environment if disposed of in places (landfills) that are not appropriate according to legislation.

- *The 'crossed out wheelie bin' symbol is placed on this product to encourage you to recycle wherever possible.*
 - *Please be environmentally responsible and recycle this product through your recycling facility at its end of life.*
-



This symbol indicates the “Drive” position of the coupling lever. In this position the motor is engaged and the motor brakes are operational. You can drive the wheelchair.

- *Please note that for driving purposes both motors must always be engaged.*



This symbol indicates the “Push” position of the coupling lever. In this position the motor is disengaged and the motor brakes are not operational. The wheelchair can be pushed by an attendant and the wheels turn freely.

- *Please note that the control panel must be switched off.*
 - *Please also note the information provided in section "**Pushing the wheelchair in freewheel mode**" on page 41.*
-



This symbol indicates the position of an anchor point when using a lashing system during transport.



If the symbol appears on a bright yellow sticker, the anchoring point is suitable for fixation of the wheelchair in a vehicle for use as a vehicle seat.



This wheelchair may not be used as a vehicle seat!

- *This wheelchair does not satisfy the requirements of ISO 7176-19:2001 and may not under any circumstances be used as a vehicle seat or to transport the user in a vehicle.*
 - *Using a wheelchair that does not fulfill these criteria as a vehicle seat can lead to the most severe injuries and even death in the event of a traffic accident.*
-



If the power wheelchair is fitted with a table, it is imperative that it is removed and safely stowed when transporting the wheelchair in a vehicle!

1.3 Type classification and permissible use

The Dragon erect chair is a class B electric wheelchair (for use indoors and outdoors) with an ability to overcome curbstones and obstacles restricted to 40 mm. It serves the mobility of handicapped people requiring slight to medium clinical support. This vehicle was designed for persons whose ability to walk is impaired, but who are still in terms of their eyesight and physically and mentally able to operate an electric vehicle.

Driving indoors and outdoors is carried out in the seated position. At the same time, ascending slopes and obstacles can be overcome in accordance with the technical specification. In this respect, special attention should be paid to the safety precautions shown in chapter "Safety notes" as from page **21**.

Exact details on speed, turn radius, range, tilt-resistant climbing ability, maximum obstacle height and permissible operating conditions are to be found in chapter "Technical specifications" on page **108**.

The erecting function is intended for indoor use. At the same time, restricted mobility is also possible. This, however, should be restricted to a few metres within the home, whereby the surface must be firm, even and horizontal. Good drive wheel grip is a pre-requisite for this purpose. Upright driving must always be carried out in a completely erect position. For safety reasons the speed is automatically reduced when in erect condition.

The vehicle has been successfully checked for safety in accordance with German and international standards. It satisfies the requirements according to DIN EN 12184 including EN 1021-1/-2. It has also been tested successfully for its splash water insensitiveness in accordance with EN60529 IPX4 and is thus well suited to typical central European weather conditions. Fitted with an appropriate lighting system, the vehicle is suitable for participation in road traffic in accordance with the Road Traffic Licensing Regulations.

1.4 Indications

Before using the Invacare® Vertic for the first time, you should consult your doctor! Before using the verticalizer on a daily basis, we recommend medical/physiotherapeutic accompaniment in order to become accustomed to the modified posture.

Below is a list of conditions that might make the use of this mobility product advisable. The list is not necessarily complete or exhaustive, but rather provides examples as a general guideline.

Paralysis

- Paraplegia (tetraplegia / parapareses, paraplegia)
- Meningomyelocele (Spina bifida) syndrome
- Progressive dystrophy of the muscles
- Infantile cerebral palsy
- Multiple sclerosis
- Hemiplegia in the event of central lesions
- Posttraumatic brain damage

Defect/deformation of the extremities, moderate forms

- Dysmelia
- Phocomelia
- Distinct Osteogenesis imperfecta (brittle bones)

Contraction of joints / low degree joint damage, aetiologic treatment not possible, as a result of

- Polyarthrosis
- Polyarthritis, Bechterew's disease
- Neurogenic functional disturbances

Other illnesses

- Disequilibrium
- Cachexia

Provision of electric wheelchairs for indoors and in road traffic is advised if the use of hand-operated wheelchairs is no longer possible on account of the handicap or if greater distances have to be covered on a regular basis and the wheelchair also has to be used indoors elsewhere.

The decision as to whether the model is suitable for you as user rests exclusively with the adequately skilled specialised medical staff.

1.5 Counter indications

The Invacare® Vertic must not be used when any of the following conditions are present:

- Person with vitreous bones.
- Serious hip, knee and/or ankle joint contractures.
- Orthopaedic problems/joint deformities, which could be aggravated by standing.
- Heart and circulatory illnesses.
- Users with anxiety states, which could cause an increase in spasticity.
- Persons who do not have the cognitive ability to operate an electric wheelchair
- Situations, in which no help would be available in case of technical failure of the Verticalizer.

1.6 Usability

Only use a power wheelchair when it is in perfect working order. Otherwise, you might put yourself and others at risk.

The following list does not claim to be exhaustive. It is only intended to show some of the situations that could affect the usability of your power wheelchair.

In certain situations, you should immediately stop using your wheelchair. Other situations allow you to use the wheelchair to get to your dealer.

- You should immediately stop using your power wheelchair if its usability is restricted due to:
 - brake failure
 - You should immediately contact an authorised Invacare® dealer if the usability of your power wheelchair is restricted due to:
 - the lighting system failing or being defective
 - reflectors falling off
 - worn thread or insufficient tyre pressure
 - damage to the armrests (e.g. torn armrest padding)
 - damage to the legrest hangers (e.g. missing or torn heel loops)
 - damage to the postural belt
 - damage to the joystick (joystick cannot be moved into the neutral position)
 - cables that are damaged, kinked, pinched or have come loose from the holder
 - the wheelchair drifting when braking
 - the wheelchair pulling to one side when moving
 - unusual sounds developing or occurring
- Or if you have the feeling that something is wrong with your wheelchair.

1.7 Warranty

The terms and conditions of the warranty are part of the general terms and conditions particular to the individual countries in which this product is sold.

1.8 Life expectancy

We estimate a life expectancy of five years for this product, provided it is used in strict accordance with the intended use as set out in this document and all maintenance and service requirements are met. The estimated life expectancy can be exceeded if the product is carefully used and properly maintained, and provided technical and scientific advances do not result in technical limitations. The life expectancy can also be considerably reduced by extreme or incorrect usage. The fact that we estimate a life expectancy for this product does not constitute an additional warranty.

2 Safety notes



READ WELL BEFORE OPERATION!

2.1 General safety notes



Danger of injury if mobility device is used in any other way than the purpose described in this manual!

- *Only ever use the mobility device in accordance with the instructions in this User's Manual (see chapter "Type classification and permissible use" on page 16).*
- *Pay strict attention to the safety information.*

Danger of injury if the mobility device is driven when ability to operate a vehicle is impaired by medication or alcohol!

- *Never drive the mobility device under the influence of medication or alcohol. If necessary, the mobility device must be operated by an attendant who is physically and mentally able.*

Danger of damage or injury if mobility device is accidentally set into motion!

- *Switch the mobility device off before you get in, get out or handle unwieldy objects.*
 - *When the drive is disengaged, the brake inside the drive is deactivated. For this reason, pushing the mobility device by an attendant is only recommended on flat surfaces, never on gradients. Never leave your mobility device on a gradient with its motors disengaged. Always re-engage the motors immediately after pushing the mobility device (see chapter "Pushing the wheelchair in freewheel mode" on page 41).*
-



Danger of injury if the mobility device is switched off while driving, for example by pressing the On/Off Button or disconnecting a cable, due to it coming to an abrupt, sharp stop!

- *If you have to brake in an emergency, simply release the joystick which will bring you to a halt. (refer to the joystick operating manual for more information).*

Danger of injury when transferring mobility device to a vehicle for transport with the occupant seated in it!

- *It is always better to transfer the mobility device to a vehicle without the occupant seated in it.*
- *If the mobility device needs to be loaded up a ramp together with its driver, ensure that the ramp does not exceed the maximum safe slope (see chapter "Technical specifications" from page 108).*
- *If the mobility device does need to be loaded using a ramp which exceeds the maximum safe slope (see chapter "Technical specifications" from page 108), then you must use a winch. An attendant can safely monitor and assist the loading process.*
- *As an alternative you can use a platform lift. Ensure that the total weight of the mobility device including the user does not exceed the maximum permissible weight for the platform lift or winch if you are using.*

Danger of injury if maximum permissible load is exceeded!

- *Do not exceed the maximum permissible load (see chapter "Technical specifications" from page 108).*
 - *The mobility device is only designed for use by a single occupant whose maximum weight does not exceed the maximum permissible load of the device. Never use the mobility device to transport more than one person.*
-



Danger of injury due to wrong lifting or dropping of heavy components!

- *When maintaining, servicing or lifting any part of your mobility device, take into account the weight of the individual components especially the batteries. Be sure at all times to adopt the correct lifting posture and ask for assistance if necessary.*

Danger of falling out of the mobility device.

- *Do not slide forward on the seat, do not lean forward between your knees, do not lean backwards out over the top of the backrest, for example to reach an object.*
- *If a posture belt is installed, it should be correctly adjusted and used each time you use the mobility device.*
- *When transferring to a different seat, position the mobility device as close as possible to the new seat.*

Danger of injury by moving parts!

- *Make sure that no injury is incurred by moving parts of the mobility device, like wheels or one of the Lifter Modules (if fitted), especially when children are around.*

Risk of injury from hot surfaces!

- *Do not leave the wheelchair in direct sunlight for prolonged periods. Metal parts and surfaces such as the seat and armrests can become very hot.*

Danger of fire or breaking down due to electric devices being connected!

- *Do not connect any electric devices to your mobility device that are not expressly certified by Invacare® for this purpose. Have all electrical installations done by your authorised Invacare® Dealer.*
-

2.2 Safety information with regard to care and maintenance



Danger of accident and loss of guarantee if maintenance is insufficient!

- *For reasons of safety and in order to avoid accidents which result from unnoticed wear, it is important that this electric mobility product undergoes an inspection once every year under normal operating conditions (see inspection plan contained in service instructions).*
 - *Under difficult operating conditions such as daily travel on steep slopes, or in the case of use in medical care cases with frequently changing wheelchair users, it would be expedient to carry out intermediate checks on the brakes, accessories and running gear.*
 - *If the mobility product is to be operated on public roads, the vehicle driver is responsible for ensuring that it is in an operationally reliable condition. Inadequate or neglected care and maintenance of the mobility product will result in a limitation of the manufacturer's liability.*
-

2.3 Safety information on electromagnetic interference

This electric vehicle was successfully tested in accordance with International standards as to its compliance with Electromagnetic Interference (EMI) regulations. However, electromagnetic fields, such as those generated by radio and television transmitters, and cellular phones can influence the functions of electric vehicles. Also, the electronics used in our vehicles can generate a low level of electromagnetic interference, which however will remain within the tolerance permitted by law. For these reasons we ask you to please observe the following precautions:



WARNING: Danger of malfunction due to electromagnetic interference!

- *Do not switch on or operate portable transceivers or communication devices (such as radio transceivers or cellular phones) when the vehicle is switched on.*
 - *Avoid getting near strong radio and television transmitters.*
 - *In case the vehicle should be set in motion unintentionally or the brakes are released, switch it off immediately.*
 - *Adding electrical accessories and other components or modifying the vehicle in any way can make it susceptible to electromagnetic interference. Keep in mind that there is no sure way to determine the effect such modifications will have on the overall immunity of the electronic system.*
 - *Report all occurrences of unintentional movement of the vehicle, or release of the electric brakes to the manufacturer.*
-

2.4 Safety information on driving and freewheel mode



Danger of injury if the wheelchair tips over!

- *Inclines and declines can only be travelled up to the maximum safe slope (see chapter "Technical specifications" from page 108).*
 - *Always return the backrest of your seat or the seat tilt to an upright position before ascending slopes. We recommend that you position the seat backrest and the seat tilt (if fitted) slightly to the rear before descending slopes.*
 - *Only ever drive downhill at a maximum of 2/3 of the top speed. Avoid abrupt braking or accelerating on gradients.*
 - *If at all possible, avoid driving on slippery surfaces (such as snow, gravel, ice etc.) where there is a danger of you losing control over the vehicle, especially on a gradient. If driving on such a surface is inevitable, then always drive slowly and with the utmost caution.*
 - *Never attempt to overcome an obstacle when on an uphill or downhill gradient.*
 - *Never attempt to drive up or down a flight of steps with your wheelchair.*
 - *When overcoming obstacles, always observe the maximum obstacle height (see chapter "Technical specifications" from page 108 and information about overcoming obstacles in chapter "Taking Obstacles" from page 37).*
 - *Avoid shifting your centre of gravity as well as abrupt joystick movements and changes of direction when the wheelchair is in motion.*
 - *Never use the wheelchair to transport more than one person.*
 - *Do not exceed the overall maximum permissible load or the maximum load per axle (see chapter "Technical specifications" on page 108).*
 - *Note that the wheelchair will brake or accelerate if you change the Driving Mode whilst the wheelchair is in motion.*
-



Danger of breaking down in adverse weather conditions, i.e. extreme cold, in an isolated area!

- *If you are a user with severely limited mobility, we advise that in the case of adverse weather conditions DO NOT attempt a journey without an accompanying attendant!*

Danger of injury if your foot slides off the footrest and gets caught underneath the wheelchair when it is in motion!

- *Make sure each time before you drive the wheelchair that your feet are squarely and securely in place on the footplates, and that both legrests are properly locked into place.*

Danger of injury if you collide with an obstacle when driving through narrow passages such as doorways and entrances!

- *Drive through narrow passages in the lowest driving mode and with due caution.*

If your power wheelchair has been fitted with angle-adjustable legrests, there is a danger of personal injury and damage to the wheelchair if you drive the wheelchair with the legrests raised!

- *To avoid unwanted displacement of the wheelchair centre of gravity to the front (especially when travelling downhill) and in order to avoid damage to the wheelchair, angle-adjustable legrests must always be lowered during normal travelling.*
-



WARNING: Danger of injury to occupant and damage to wheelchair if driver is not mentally and physically able to keep full control of the vehicle at all times!

- *If necessary, operation of the Powerchair must be performed by an attendant!*
-



CAUTION: Danger of tipping! Anti tip wheels (stabilisers) are only effective on firm ground! They sink in on soft ground such as grass, snow or mud if the mobility device rests itself on them. They lose their effect and the mobility device can tip over.

- *Only drive with extreme care on soft ground, especially during uphill and downhill journeys. In the process pay increased attention to the tip stability of the mobility device.*
-

2.5 Safety information regarding changes and modifications to the mobility device



CE marking of the wheelchair

The conformity assessment/ CE marking was carried out in accordance with Directive 93/42 EEC / MPG (Medical Devices Act) and only applies to the complete product.

The CE marking is invalidated if components or accessories are replaced or added that have not been approved for this product by Invacare.

In this case, the company that adds or replaces the components or accessories is responsible for the conformity assessment/ CE marking or for registering the wheelchair as a special design and for the relevant documentation.



CAUTION: Danger of injuries and damage to mobility aid due to unapproved components and accessory parts!

Seating systems, additions and accessory parts which have not been approved by Invacare® for use with this mobility aid can affect the tipping stability and increase tipping hazards!

- *Only ever use seating systems, additions and accessory parts which have been approved by Invacare® for this mobility aid!*

Seating systems which are not approved by Invacare® for use with this power wheelchair do not, under certain circumstances, comply with the valid standards and could increase the flammability and the risk of skin irritation.

- *Only use seating systems that have been approved by Invacare® for this power wheelchair.*

Electrical and electronic components which have not been approved by Invacare® for use with this mobility aid can cause fire hazards and lead to electromagnetic damage!

- *Only ever use electrical and electronic components which have been approved by Invacare® for this mobility aid!*

Batteries which have not been approved by Invacare® for use with this mobility aid can cause chemical burns!

- *Only ever use batteries which have been approved by Invacare® for this mobility aid!*
-

2.6 Safety information for the verticalizer



CAUTION: Danger of tipping!

- *When the verticalizer is raised drive operation only serves positioning and not normal driving.*
 - *Never drive over uneven ground, on an upward or downward slope or over obstacles when the verticalizer is raised.*
-



CAUTION! The user can fall out of the seat if the restraining systems are not used.

- *Only raise the verticalizer if all restraining systems – restraining belt and knee strap – have been applied and locked properly.*
-



CAUTION! If the seat depth is not adjusted properly, there is danger of the verticalizer being destroyed.

- *The lower and upper perforated bars of the parallelogram must be adjusted analogue to each other. In the event of diversity in adjustment the verticalizer will be destroyed when operated due to the modified geometry.*
-



CAUTION! The breast belt lock can lose strength due to soiling or wear!

- *The belt lock velcro strap must not be soiled or clogged with fluff, fabric residue or similar foreign bodies! It must be in a clean, undamaged condition!*
 - *The belt lock velcro loop strip must not be frayed or otherwise damaged or soiled!*
 - *The seams which fix the velcro strap or velcro loop strip to the belt must be in perfect undamaged condition! The velcro strap or velcro loop strip may not loosen themselves from their substrate!*
 - *When locking the belt, the velcro strap and velcro loop strip must completely overlap each other. The strength of the lock is considerably decreased if the velcro strap and velcro loop strip only partially overlap.*
 - *To check the functionality of the belt, the user should lean forwards and exert pressure on the belt when the verticalizer is lowered and the belt is fastened. The belt lock must not loosen or release when this is done! In doing so, the user must be safeguarded by an attendant so that he cannot fall forwards out of the electric wheelchair if the lock should release.*
-

3 Key features

1) Release handle for headrest adjustment

2) Sliding handle

3) Chest belt

4) Set screw for adjusting the position of the remote

5) Side section fastening screw

6) Disengaging lever

7) Knee strap unlocking lever

8) Remote

9) Knee strap

10) Foot plate

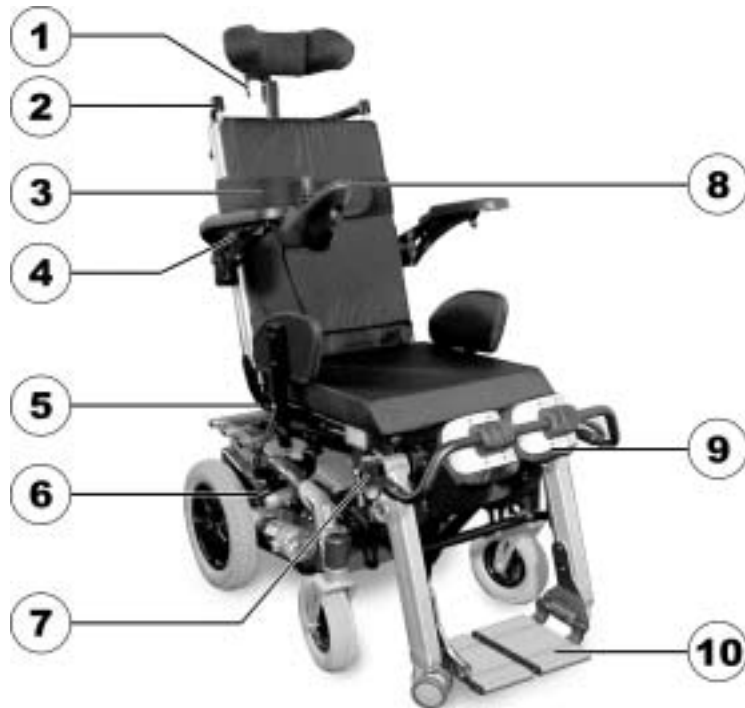

4 The position of the labels on the product

- 1) Note: Remove the table before transporting
- 2) Identification label sticker on the actuator of the verticalizer (also included in the pass card)
- 3) Identification of the lashing eyes at the front and back
Warning that the wheelchair may not be used as a vehicle seat
- 4) Warning regarding the use of the verticalizer
- 5) Identification of the position of the coupling lever for driving and push operation



The symbols on the labels are explained in section "**Important symbols found on the vehicle**" on page 13.

5 Getting in and out of the wheelchair



Important information on boarding and alighting from the side.

In order to board and alight from the side the armrest must be swivelled upward. A clothing guard can be installed as an option in connection with the travelling armrest. This must also be removed in order to board.

5.1 Raise the parallel sliding armrest / remove the skirtguard (optional)

- Swing up the armrest (1).
- Loosen the wing screw (2).
- Pull the clothing guard out of the receptacle.



Getting into the wheelchair:

- Position your wheelchair as close as possible to your seat. This might have to be done by an attendant.
- Switch your wheelchair off.
- Apply the manual wheel lock of your wheelchair (if existing).
- Detach the skirt guard of your wheelchair or swivel it up.
- Now slide into the wheelchair.



Getting out of the wheelchair:

- Drive your wheelchair as close as possible to your seat.
- Switch your wheelchair off.
- Apply the manual wheel lock of your wheelchair (if existing).
- Detach the skirt guard of your wheelchair or swivel it up.
- Now slide onto your new seat.



NOTE:

If you do not have sufficient muscle strength, you should ask other persons for help. Use a sliding board, if possible.

6 Driving



NOTE

The maximum load capacity that is stated in the technical data only states that the system is designed for this mass in total. However, this does not mean that one can sit a person with this body weight in the wheelchair without restrictions. Attention must be paid to the body proportions, such as height, weight distribution, abdominal girth, leg and calf girth and seat depth. These factors have a strong influence on driving features such as tilt stability and traction. The permissible axle loads in particular must be adhered to (see chapter "**Technical specifications**" as from page **108**)! It may possibly be necessary to carry out adaptations to the seat system.

6.1 Before driving for the first time...

Before you take your first trip, you should familiarise yourself well with the operation of the vehicle and with all operating elements. Take your time to test all functions and driving modes.



NOTE:

If installed, make sure to properly adjust and use the postural belt each time you use the wheelchair.

Sitting Comfortably = Driving Safely

Before each trip, make sure that:

- **You are within easy reach of all operating controls.**
- **The battery charge is sufficient for the distance intended to be covered.**
- **The postural belt (if installed) is in perfect order.**

- The rear mirror (if installed) is adjusted so you can look behind at all times without having to bend forward or shift your seating position.

6.2 Taking Obstacles

6.2.1 Maximum obstacle height

You can find information about maximum obstacle heights in the chapter entitled "**Technical specifications**" from page **108**.

6.2.2 Safety information when ascending obstacles



CAUTION: Danger of Tipping Over!

- *Never approach obstacles at an angle but at 90 degrees as shown below.*
 - *Put your backrest into an upright position before climbing an obstacle.*
-



CAUTION: Danger of tipping!

- *Never drive over obstacles with an erected verticalizer. Always lower the verticalizer completely prior to this.*
-



ATTENTION: Risk of falling out of the chair and damage to the power wheelchair such as broken castors!

- *Never approach obstacles that are higher than the maximum climbable obstacle height. For the maximum climbable obstacle height, see "**Technical specifications**" on page **108**.*
 - *If unsure whether the kerb climb is possible or not, move away from the obstacle and if possible find another location.*
-

6.2.3 The correct way to overcome obstacles

Ascending

- Approach the obstacle or the kerb slowly, head-on and at a right angle.
- Depending on the wheel drive type, stop in one of the following positions:
 - In the case of centrally driven wheelchairs: 5 - 10 cm before the obstacle.
 - For all other drives: approx. 30 - 50 cm in front of the obstacle.
- Check the position of the front wheels. They must be in driving direction and at right angles to the obstacle.
- Approach slowly and keep at a consistent speed until the rear wheels have also passed over the obstacle.

Descending

The approach to descend an obstacle is the same as to ascend it with the difference that you need not stop before descending.

- Descend the obstacle very slowly.

Right



Wrong



6.3 Driving up and down gradients

For information concerning the maximum safe slope, please see chapter "**Technical specifications**" starting on page 108.



WARNING: Danger of tipping over!

- *Only ever drive downhill at a maximum of 2/3 of the top speed. Avoid sudden changes of direction or abrupt braking when driving on slopes.*
 - *Always return the backrest of your seat or the seat tilt (if adjustable seat tilt is available) to an upright position before ascending slopes. We recommend that you position the seat backrest or the seat tilt slightly to the rear before descending slopes.*
 - *Always lower the lifter (if fitted) to its lowest position before ascending or descending a slope.*
 - *Never attempt to ascend or descend a slope on slippery surfaces or where there is a danger of skidding (such as wet pavement, ice etc).*
 - *Avoid trying to get out of the vehicle on an incline or a gradient.*
 - *Always drive straight in the direction the road or path you are on goes, rather than attempting to zigzag.*
 - *Never attempt to turn around on an incline or a slope.*
-



CAUTION: Danger of tipping!

- *When the verticalizer is raised drive operation only serves positioning and not normal driving.*
 - *Never drive over uneven ground, on an upward or downward slope or over obstacles when the verticalizer is raised.*
-

6.4 Parking and stationary

When parking your vehicle or if your vehicle is stationary for a prolonged period:

- Switch the vehicle's power system off (ON-/OFF key).
- Activate your anti-theft lock, if existing.

6.5 Use on public roads

If you wish to use your wheelchair on public roads and lighting is required by national legislation, then your wheelchair needs to be equipped with an appropriate lighting system.

Please contact your Invacare® dealer if you have any questions.

7 Pushing the wheelchair in freewheel mode

The motors of the wheelchair are equipped with automatic brakes, preventing that the wheelchair starts rolling out of control when the joystick box is switched off. When pushing the wheelchair manually whilst freewheeling, the magnetic brakes must be disengaged.

7.1 Disengaging Motors



Danger of the vehicle running away!

- *When the motors are disengaged (for push operation whilst freewheeling), the electromagnetic motor brakes are deactivated! When the vehicle is parked, the levers for engaging and disengaging the motors must without fail be locked firmly into the "DRIVE" position (electromagnetic motor brakes activated)!*
-



NOTE:

The wheelchair disengaging mechanism is fitted with a gas pressure spring which prevents overloading the disengager. When the drive wheels are under torque load - for example if the wheelchair is on an incline - the gas pressure spring is activated. When the engaging lever is pressed forwards it does not remain in the "Pushed" position, but moves automatically back to the "Drive" position. To disengage the drive, the drive wheels must be unloaded by moving the wheelchair slightly forwards and backwards again.



NOTE:

The motors may only be disengaged by an attendant, not by the user!

This ensures that the motors are only disengaged if an attendant is available to secure the wheelchair and prevent unintended rolling.

The lever for disengaging the motors is on the rear right side on the wheelchair chassis.

Disengaging motors:

- Switch off remote.
- Withdraw the locking pin (1). Push the engaging lever (2) forwards. If necessary, move the wheelchair slightly forwards and backwards during disengaging. The motors are now disengaged.

Re-engaging motors

- Pull the engaging lever (2) to the rear. The motors are now re-engaged.

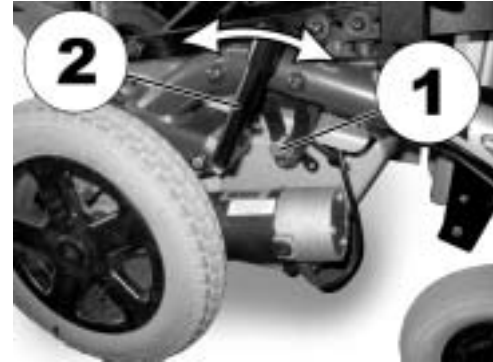

8 Remotes

Your wheelchair may be equipped with one of several different remotes. For information on the different functions and how to operate a particular remote, please see its corresponding User Manual (enclosed).

9 Adjusting the wheelchair to the user's seating posture



CAUTION: Damage to wheelchair and accident hazard! It is possible that collisions can occur between wheelchair components due to various combinations of adjustment options and their individual settings!

- *The wheelchair is fitted with an individual, multiply adjustable seating system including adjustable legrests, armrests, a headrest or other options. These adjustment options are described in the following chapters. They are used to adapt the seat to the physical requirements and the condition of the user. When adapting the seating system and the seat functions to the user, ensure that no wheelchair components collide.*
-

The alignment of the verticalizer and the seat position of the user should be carried out in the following order:

1. Seat depth
2. Lower leg length
3. Back height
4. Knee cushion distance to shin
5. Knee cushion height
6. Distance between the knee cushions
7. Armrest height
8. Armrest angle
9. Chest belt height
10. Backrest angle
11. Headrest
12. Stand-up angle

9.1 Torques

Please note the following torques for all adjustment and maintenance work during which it is necessary to loosen and re-tighten screws or nuts:

Thread diameter	M5	M6	M8	M10	M12	M16
Fastening torque (Nm)	3.4-4.9	5.9-7.8	14-19	25-34	44-61	115-155
Fastening torque (mkp)	0.35-0.80	0.60-0.80	1.4-1.9	2.6-3.5	4.5-6.2	11.5-16

9.2 Adjusting the seat depth

To optimally adjust the wheelchair to the user's needs, it is advisable to have the seat depth adjusted individually by an authorised Invacare® dealer.

There are perforated rails under the seat for adjusting the seat depth. This results in the following seat depths: 38, 40, 42, 44 and 46 cm. These values are etched into the lower perforated rails as a positioning guide. The electric wheelchair is set at the max. seat depth of 46 cm when supplied.



CAUTION! Danger of injury

- *When carrying out work underneath the raised seat unit it must be ensured that this is not lowered. The electric wheelchair must be switched off.*
-



CAUTION! If the seat depth is not adjusted properly, there is danger of the verticalizer being destroyed!

- *The lower and upper perforated rails of the parallelogram must be adjusted in an analog fashion towards each other. In the event of diversity in adjustment the verticalizer is destroyed upon operation due to the change in geometry.*
-



What should be observed when adjusting the seat depth?

If the seat depth adjustment is too short, the forces on the body whilst standing up are too great.
If the seat depth adjustment is too long, the user can “collapse” whilst standing up.



Pre-requisites:

- 4 mm Allen key
 - 6 mm Allen key
 - 13 mm open-ended spanner
-

The picture on the right shows the position of the seat plate guide screws (1) and the fastening screws of the perforated rails (2).



- Loosen the seat plate guide screw (1).
- Loosen the fastening screws of the perforated rails (2) using an Allen key and an open-ended spanner and pull out.
- Adjust the perforated rails to the desired seat depth.
- Screw the screws back in and tighten using an Allen key and an open-ended spanner.

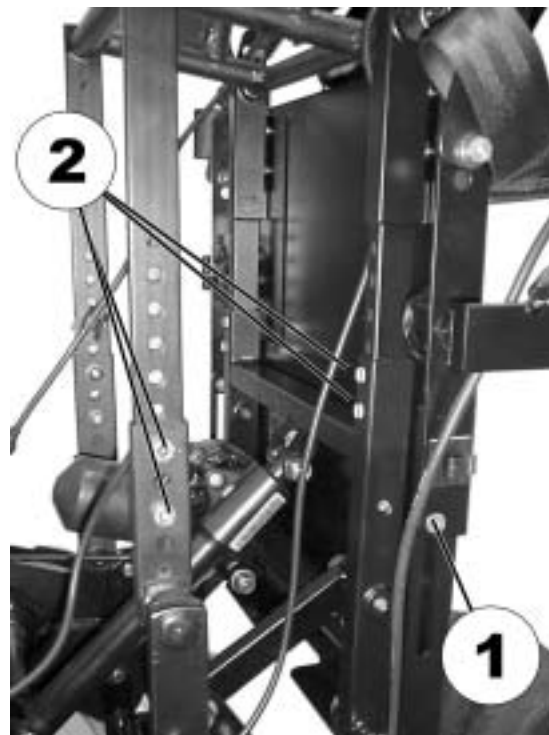

9.3 Legrest

9.3.1 Setting the lower leg length of the legrest



The adjustment range of the calf length depends on the seat height!

Depending on the model, the calf length has two possible adjustment ranges (measured including the seat cushion):

- 36...45 cm
 - 41...50 cm
-



What should be observed when adjusting the lower leg length?

When adjusting the lower leg length, please make sure that the legrests are individually adjusted to correctly fit the length of the user's legs. The thighs must be resting on the seat cushion.



Pre-requisites:

- 5 mm Allen key
-

- Loosen the screws (1) using the Allen key.
- Set the foot plate to the desired height.
- Re-tighten the screws.



9.4 Changing the height of the backrest

By cutting off a segment of the backrest sling (underneath the backrest cushion), the height of the backrest can be permanently shortened once by 5 cm.



Requirements:

- Allen key 3 mm
 - Scissors
-
- Remove seat cushion.



- Remove backrest cushion.



To change the height of the backrest, first the covers (A) on the ends of the backrest support tubes need to be loosened.

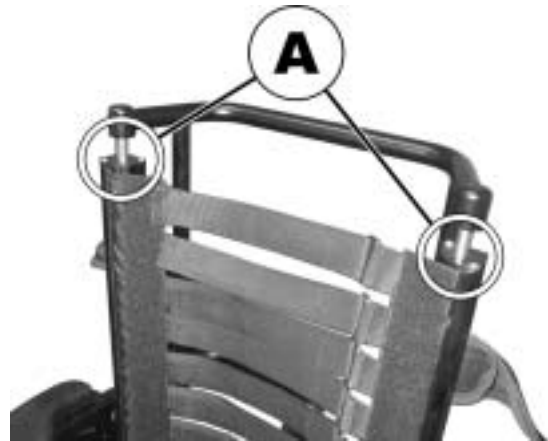

- Loosen and remove the screws (1) that hold the covers, using the 3 mm Allen key.



- Turn each cover so that the gap (1) is pointing towards the front, positioned directly over the end of the fixation rod of the backrest sling.



- Pull the backrest sling up through the opening.



- Using the scissors, cut the last segment of the backrest sling off, as shown in the illustration.



- Push the backrest sling and, if necessary, the fixation rod back down into the backrest frame.



- Re-position the screws (1) in the covers on the ends of the backrest frame tubes and tighten with the Allen key.



9.5 Restraining straps for the legs

9.5.1 Opening and closing the restraining strap



CAUTION: If the retaining clamp lock is not correctly and completely closed, and the locking lever is then pressed down using force, the locking mechanism can break! There is then a hazard that the user can fall out of the wheelchair.

- *The locking lever may never be pressed down using force!*
 - *The fork at the end of the retaining clamp has a small cone on the bottom of it which fits into the corresponding recess in the locking mechanism. The fork needs to be guided into the locking mechanism as far as the stop so that the cone fits into the recess. The locking lever may only be pressed down at this point!*
-

WRONG!



RIGHT!

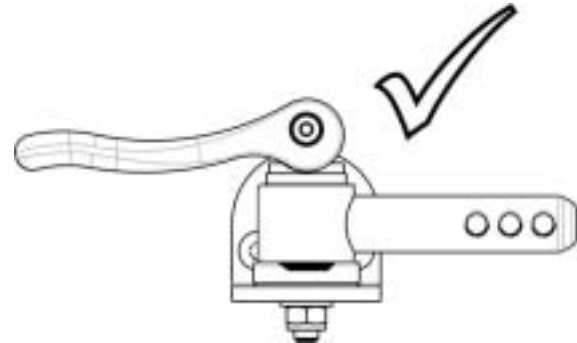

WRONG!

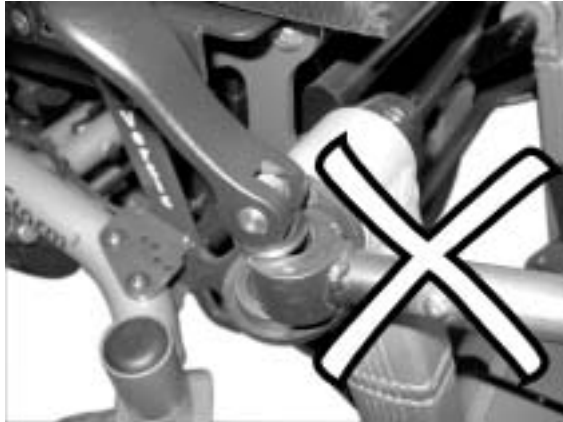

RIGHT!

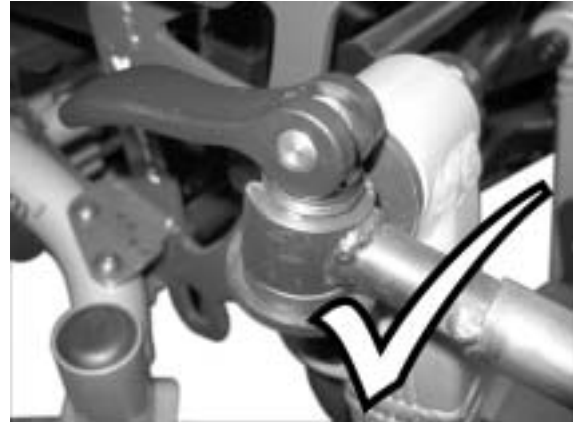

- Flip lever (1) over. The restraining bar is released.
- Open the restraining strap (2) to the front.
- If necessary, loosen the locking lever on the other side and remove the entire strap.
- The restraining strap is re-fitted in the reverse order and closed.



9.5.2 Adjusting the position of the release lever



WARNING: Danger of injury, in case one of the fixation bolts loosens or falls out, as a result of incorrect assembly!

- *The lower nut on the fixation bolt must always be tightened to 15 Nm after all assembly work!*



Requirements:

- Open-end spanner 13 mm
- Torque spanner 13 mm

- Loosen the fixation nut (1) of the release lever.
- Adjust the lever to the desired position.
- Re-tighten the nut to 15 Nm.



9.5.3 Adjusting the retaining bar and knee cushions

9.5.3.1 Setting the depth of the restraining strap



Pre-requisites:

- 5 mm Allen key
-



What should be observed when adjusting the distance of the knee cushion to the shin?

If the distance of the knee cushion to the shin is too small, great pressure is asserted on the legs when standing up. If the distance is too large, the user can “collapse” whilst standing up.

The holes in the inner and outer tubes are spaced differently. The many possible combinations of holes provide the ability to finely adjust the retaining bar.

- Use the screw wrench to loosen the Allen screws (1) and remove.
- Set the desired knee strap position (choose hole pattern combination inner tube/outer tube).
- Replace the screws and tighten.



9.5.3.2 Adjusting the height of the knee cushions



Pre-requisites:

- Crosstip screwdriver
-

**WARNING: Danger of injury!**

- *The knee pads should not press directly on the knees! The upper edge of the knee pads should be positioned just below the upper end of the shin bone!*
-

- Remove the knee cushion upholstery.



- Loosen the screws (1) using the crosstip screwdriver and remove.



- Move the knee cushions to the desired position.
- Re-insert the screws and tighten.



9.5.3.3 Setting the width of the knee cushions



Pre-requisites:

- 4 mm Allen key
-
- Use the screw wrench to loosen the Allen screws (1).
 - Set the desired knee cushion position.
 - Re-tighten the screws.



9.6 Posture belt for the legs

9.6.1 Setting the knee cushion depth



What should be observed when adjusting the distance of the knee cushion to the shin?

If the distance of the knee cushion to the shin is too small, great pressure is asserted on the legs when standing up. If the distance is too large, the user can “collapse” whilst standing up.

- Open the knee cushion Velcro fastening.



- Adjust the required length.



- Check to see whether the knee cushion depth is correctly adjusted.



9.6.2 Setting the knee cushion height



WARNING: Danger of injury!

- *The knee pads should not press directly on the knees! The upper edge of the knee pads should be positioned just below the upper end of the shin bone!*
-

**Pre-requisites:**

- 4 mm Allen key
-

You can adjust the height of the knee cushion by adjusting the holders.

- Undo the Allen screw on the inside of the latch knob (1) with the open-ended spanner.
- Set the required height for the knee cushion.
- Retighten the screw.
- Repeat the steps for the latch knob on the other side.



9.6.3 Attaching the knee cushion

- Hang the knee cushion hook in the holder.



- The knee cushion can now be used.



9.7 Adjusting the armrests and the control panel

9.7.1 Adapting the height of the armrests



Pre-requisites:

- 5 mm Allen key
-

- Loosen the eight Allen screws (1) (only the four on the right side are to be seen in the picture).
- Adjust the height of the armrests.
- Re-tighten the screws.



9.7.2 Setting the angle of the swing-up armrest



Pre-requisites:

- 5 mm Allen key
 - 13 mm open-ended spanner
-



WARNING: Damage to the wheelchair may result if the height of armrests is unevenly adjusted!

- *The armrests should only ever be adjusted parallel to each other, never higher on one side and lower on the other!*
-

- Use the open-ended spanner to loosen the counternut (1).
- Adjust the Allen screw (2) until the desired setting angle of the armrest has been achieved.
- Re-tighten the counternut (1).



9.7.3 Setting the resistance of the swing-up armrest

The swing-up armrest is prevented from lowering under its own weight by the pre-set resistance.



Pre-requisites:

- 5 mm Allen key
-

- Adjust the Allen screw (1) until the desired resistance of the armrest has been achieved.



9.7.4 Adapting the control panel to the length of the user's arm

- Loosen the wing screw (1).
- Set the remote to the desired length by pushing forward or backward.
- Re-tighten the screw.



9.7.5 Setting the height of the remote

- Loosen the wing screw (1).
- Set the remote to the desired height.
- Re-tighten the screw.

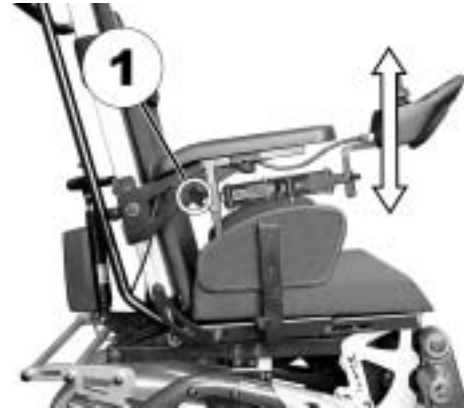

9.7.6 Adjusting the width of the armrests

The distance between the side sections can be adjusted by 5.5 cm on both sides (11 cm in total).



Requirements:

- Allen key 8 mm
-

Where to find the adjustment screws

The picture shows the position of the screws (1) (underneath the seat frame, hidden in the picture), that allow an adjustment to the width of the side sections.

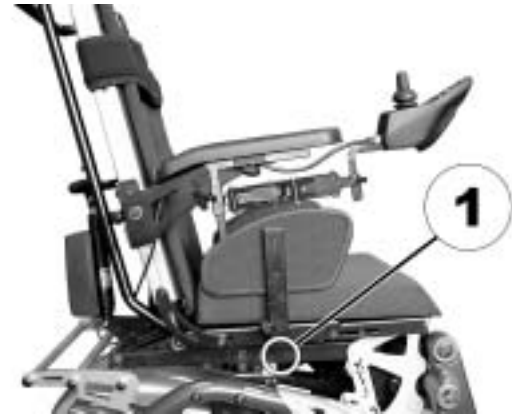

Doing the adjustment

- Loosen the screw (1).
- Set the side section in the desired position.
- Re-tighten the screw.
- Check the firm fit of the side section.
- Repeat the process for the second side section.

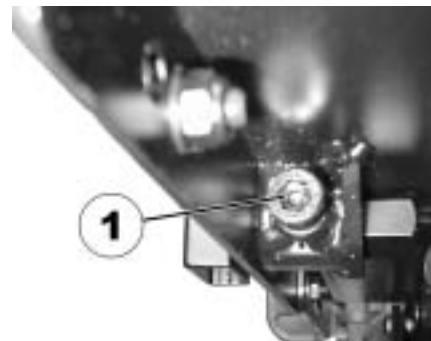

9.8 Adapting the height of the chest belt



Pre-requisites:

- 5 mm Allen key
-



WARNING: Danger of falling out of the wheelchair, if the chest belt comes undone!

- *Make sure that the Velcro strips on the chest belt cover each other completely.*
 - *Always secure the chest belt using the additional belt (with snap lock) before the chair is brought into an upright position.*
-

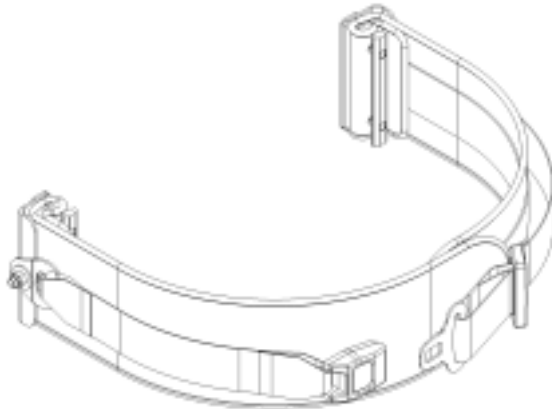

What should be observed when adjusting the height of the chest belt?

The height of the chest belt depends on the stability of the upper part of the body. The lesser the stability, the higher the belt adjustment.

- Loosen the Allen screws (1).
- Adjust the height of the belt.
- Re-tighten the screws.



9.9 Adjusting the backrest

The backrest can be optionally adjusted using an electric actuator. Please consult the instruction manual for your remote for information about electrical adjustment.

9.10 Adjusting the headrest

9.10.1 Adjusting the height

- Loosen the hand wheel (1).
- Move the headrest to the desired height.
- Re-tighten the hand wheel.



9.10.2 Setting the position

- Loosen the release handle (1,2 or 3).
- Move the headrest to the desired position.
- Re-tighten the release handle.



9.11 Adjustment of the stand-up angle



Pre-requisites:

- Screwdriver, flat, width of edge approx. 6 mm
-



WARNING: The Verticalizer could be destroyed if the position of the upper shut-off switches is changed!

- *Never modify the position of the upper shut-off switches!*
-

The control box (1) for the limit stop of the verticalizer is to be found under the seat.

- Raise the verticalizer.



- Use the screwdriver to carefully release the rubber cover at the upper end of the control box and remove.



There are three limit switches in the control box, two at the upper end and one at the lower end. The lower limit switch (1) is the one used to adjust the stand-up angle. Never change the position of the upper shut-off switches!

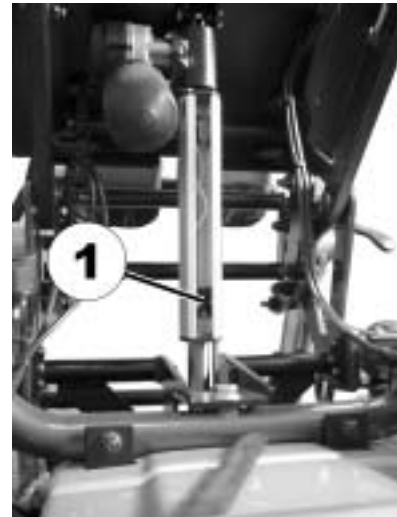

- Use the screwdriver to loosen the fastening screw on the limit switch (1).
- Slide the limit switch upward or downward.
- Upward = actuator is shut down earlier when standing up, user is erected to a lesser degree.
- Downward = actuator is shut down later when standing up, user is erected to a greater degree.
- Re-tighten the fastening screw.

- Re-position the rubber cover and press carefully into the groove using the screwdriver.

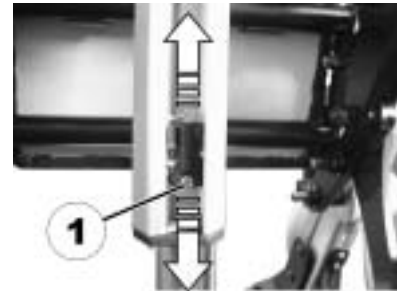

9.12 Postural belts

A postural belt is an option which can either be fixed to the wheelchair ex-works or can be retrofitted by your specialist dealer. If your wheelchair is fitted with a postural belt, your specialist dealer will have informed you about fitting and usage.

The postural belt is used to help the wheelchair user keep an optimum sitting position. Correct use of the belt assists the user in sitting securely, comfortably and well-positioned in the wheelchair, especially for such users who do not have such a good sense of balance while sitting.



NOTE:

We recommend using the postural belt whenever the wheelchair is used. The belt should be tight enough to ensure that you are sitting comfortably and that your body is in the correct sitting position.

9.12.1 Types of postural belts

Your wheelchair can be fitted with the following postural belt types ex-works. If your wheelchair has been fitted with a different belt to those listed below, please ensure that you have received the manufacturer's documentation with regard to correct fitting and use.

Belt with metal buckle, adjustable one side

Belt can only be adjusted on one side which can result in the buckle not sitting centrally.



Belt with metal buckle, adjustable both sides

Belt can be adjusted on both sides. This means that the buckle can be centrally positioned.



9.12.2 Adjusting the postural belt correctly

The following information refers to the lap belt. For information on adjusting the chest belt, please refer to "Adapting the height of the chest belt" on page **74**.

- Ensure that you are sitting correctly, which means that you are sitting right at the back of the seat, your pelvis is positioned erect and as symmetrically as possible, not to the front, to the side or at one edge of the seat.
- Position the postural belt so that your hipbones can be easily felt above the belt.
- Adjust the belt length using one of the adjustment aids described above. The belt should be adjusted so that you can fit a flat hand between the belt and your body.
- The buckle should be positioned as centrally as possible. In doing so, please carry out adjustments on both sides as much as possible.
- Please check your belt every week to ensure that it is still in good working condition; to ensure it has no damage or wear, and that it is fixed properly to the wheelchair. If the belt is only fastened with a bolted connection, ensure that the connection has not loosened or undone. You can find more information about maintenance work on belts in the service manual, which is available from Invacare®.

9.13 Adjusting the table (option)



CAUTION: Injury hazard or material damage if a power wheelchair which is fitted with a table is transported in a vehicle!

- *If a table is fitted, always remove it before transporting the wheelchair.*



9.13.1 Swivelling the table upward



CAUTION! Risk of injury! When the tray is raised it does not lock in place in this position!

- *Do not tilt the tray up and leave it leaning in this position.*
- *Never attempt to drive with the tray tilted up.*
- *Always lower the tray in a controlled manner.*

- Release the quick release fastener (1).
- Open the table out to the front.



- Raise the armrest slightly.
- Swivel the table top downward and lower in a downward direction together with the armrest.



9.13.2 Adjusting the depth of the table



Pre-requisites:

- 5 mm Allen key
-

- Use the Allen key to loosen the screws (1, on both sides).
- Adjust the table to the desired depth.
- Re-tighten the screws.



9.14 Operating the verticalizer



CAUTION: Danger of tipping!

- *When the verticalizer is raised drive operation only serves positioning and not normal driving.*
 - *Never drive over uneven ground, on an upward or downward slope or over obstacles when the verticalizer is raised.*
-



CAUTION! The user can fall out of the seat if the restraining systems are not used.

- *Only raise the verticalizer if all restraining systems – restraining belt and knee strap – have been applied and locked properly.*
-

The verticalizer is controlled via the remote. Please refer to the remote manual for more information.

10 Electrical system

10.1 Electronics protection system

The vehicle drive electronics is fitted with an overload protection.

If the drive is severely overloaded over a long period (e.g. during steep climbs) and, above all, at simultaneous high external temperatures, the electronic system can overheat. In this case, the vehicle performance is gradually reduced until it comes to a standstill. The status display shows a corresponding blink code (please refer to the user manual for your remote). If you switch the drive electronics off and then on again, the error message is deleted and the electronics can be switched on again. It can however take up to five minutes until the electronics has cooled down enough for the drives to apply their full performance.

If the drive is blocked due to an insurmountable obstacle, for example a kerb or similar which is too high, and the driver attempts to run the drive for more than 20 seconds against this obstacle, the electronic system switches the drives off to avoid damage. The status display shows a corresponding flash code (please refer to the user manual for your remote). If you switch the drive electronics off and then on again, the error message is deleted and the electronics can be switched on again.

10.1.1 The main fuse



NOTE

A defective main fuse may be replaced only after checking the entire electric system. An Invacare® specialised dealer must perform the replacement. You can find information on the fuse type in chapter "**Technical specifications**" starting on page **108**.

The entire electric system of the wheelchair is protected by the main fuse against overloading.

The main fuse is to be found underneath the battery cover (1).

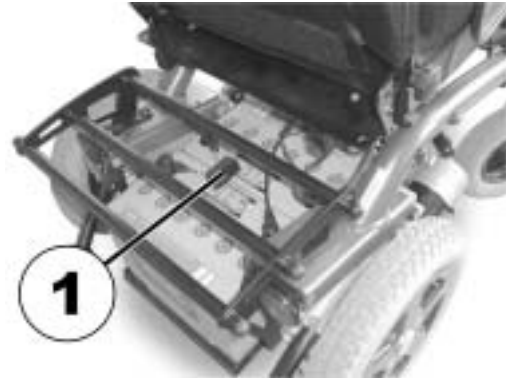

10.2 Batteries

Power is supplied by two 12 V batteries. The batteries are maintenance-free and only need regular charging.

In the following, you find information on how to charge, handle, transport, store, maintain, and use batteries.

10.2.1 Charging the batteries

10.2.1.1 General information on charging

New batteries should always be fully charged once before their first use. New batteries will be at their full capacity after having run through approx. 10 - 20 charging cycles (break-in period). This break-in period is necessary to fully activate the battery for maximum performance and longevity. Thus, range and running time of your mobility device could initially increase with use.

Gel/AGM lead acid batteries do not have a memory effect as NiCd batteries.

10.2.1.2 General instructions on charging

Follow the instructions listed below to ensure safe use and longevity of the batteries:

- Charge 12 hours prior to initial usage.
- We recommend charging the batteries daily after every discharge even after partly discharge, as well as each night over night. Depending on the level of discharge, it can take up to 12 hours until the batteries are fully charged again.
- When the battery indicator reached the red LED range, charge the batteries for 16 hours minimum, neglecting the charge complete display!
- Try to provide a 24 hour charge once a week to make sure that both batteries are fully charged.

- Do not cycle your batteries at a low state of charge without regularly recharging them fully.
- Do not charge your batteries under extreme temperatures. High temperatures above 30 °C are not recommended for charging as well as low temperatures below 10 °C.
- Use only charging devices in Class 2. This class of chargers may be left unattended during charging. All charging devices which are supplied by Invacare® comply with these requirements.
- You cannot overcharge the batteries when using the charger supplied with your vehicle, or a charger that has been approved by Invacare®.
- Protect your charger from sources of heat such as heaters and direct sunlight. If the battery charger overheats, charging current will be reduced and the charging process delayed.

10.2.1.3 How to charge the batteries

Please see the instruction manuals for your remote and battery charger for the position of the charging socket and further information about charging the batteries.



WARNING!**Risk of explosion and destruction of batteries if the wrong battery charger is used!**

- *Only ever use the battery charger supplied with your vehicle, or a charger that has been approved by Invacare®.*

Risk of electric shock and damage to the battery charger if it gets wet!

- *Protect the battery charger from water.*
- *Always charge in a dry environment.*

Risk of short circuit and electric shock if the battery charger has been damaged!

- *Do not use the battery charger if it has been dropped or damaged.*

Risk of electric shock and damage to the batteries!

- *NEVER attempt to recharge the batteries by attaching cables directly to the battery terminals.*

Risk of fire and electric shock if a damaged extension cable is used!

- *Only ever use an extension cable if it is absolutely necessary. In case you must use one, make sure it is in good condition.*

Risk of injury if using the wheelchair during charging!

- *DO NOT attempt to recharge the batteries and operate the wheelchair at the same time.*
 - *DO NOT sit in the wheelchair while charging the batteries.*
-

- Switch off the mobility device.
- Connect the battery charger to the charger socket.
- Connect the battery charger to the power supply.

10.2.1.4 How to disconnect the batteries after charging

- Once charging is complete, first disconnect the battery charger from the power supply, then disconnect the plug from the remote.

10.2.2 Storage and Maintenance

Follow the instructions listed below to ensure safe use and longevity of the batteries:

- Always store the batteries fully charged.
- Do not leave the batteries in a low state of charge for an extended length of time. Charge a discharged battery as soon as possible.
- In case your mobility device is not used for a longer period of time (that is more than two weeks), the batteries must be charged at least once a month to maintain a full charge and always be charged before use.
- Avoid hot and cold extremes when storing. We recommend to store batteries at a temperature of 15 °C.
- Gel and AGM batteries are maintenance-free. Any performance issues should be handled by a properly trained mobility device technician.

10.2.3 Instructions on using the batteries



CAUTION! Risk of damaging the batteries.

- *Avoid ultra-deep discharges and never drain your batteries completely.*
-

- Pay attention to the Battery Charge Indicator! Charge the batteries when the Battery Charge Indicator shows that battery charge is low.

How fast the batteries discharge depends on many circumstances, such as ambient temperature, condition of the surface of the road, tyre pressure, weight of the driver, way of driving and utilisation of lighting.

- Try to charge the batteries always before you reach the red LED range.

The last 3 LED (two red and one orange) mean a remaining capacity of about 15 %.

- Driving with blinking red LED's means an extreme stress for the battery and should be avoided under normal circumstances.
- When only one red LED is blinking, the Battery Safe feature is enabled. From this time, speed and acceleration is reduced drastically. It will allow you to move the mobility device slowly out of a dangerous situation before the electronic finally cuts off. This is deep discharging and should be avoided.
- Be aware that for temperatures below 20 °C, the nominal battery capacity starts to decline. For example, at -10 °C the capacity is reduced to about 50 % of the nominal battery capacity.
- To avoid damaging the batteries, never allow them to be fully discharged. Do not drive on heavily discharged batteries if it is not absolutely necessary, as this will strain the batteries unduly and shorten their life expectancy.
- The earlier you recharge the batteries, the longer they live.
- The depth of discharge affects the cycle life. The harder a battery has to work, the shorter is its life expectancy.

Examples:

- One deep discharge stresses the same as 6 normal cycles (green /orange display off).
- The battery life is about 300 cycles at 80% discharge (first 7 LED off), or about 3000 cycles at 10% discharge (one LED off).



NOTE:

The number of LED can vary depending on the remote type.

- Under normal operation, once a month the battery should be discharged until all green and orange LED are off. This should be done within one day. A 16 hour charge afterwards is necessary as reconditioning.

10.2.4 Transporting batteries

The batteries supplied with your electric vehicle are not hazardous goods. This classification is based on the German GGVS Hazardous Goods Road Transport Ordinances, and the IATA/DGR Hazardous Goods Rail Transport / Air Transport Ordinances. Batteries may be transported without restrictions, whether by road, rail or by air. Individual transport companies have, however, guidelines which can possibly restrict or forbid certain transport procedures. Please ask the transport company regarding each individual case.

10.2.5 Handling batteries

10.2.5.1 General instructions on handling the batteries

- Never mix and match different battery manufactures or technologies, or use batteries that do not have similar date codes.
- Never mix gel with AGM batteries.
- Always have your batteries installed by a properly trained mobility device technician. They have the necessary training and tools to do the job safely and correctly.

10.2.5.2 How to handle damaged batteries correctly



WARNING:**Corrosion and burns from acid leakage if batteries are damaged!**

- *Remove clothes that have been soiled by acid immediately.*

After contact with skin:

- *Immediately wash affected area with lots of water.*

After contact with eyes:

- *Immediately rinse eyes under running water for several minutes; consult a physician.*
-

- Always wear safety goggles and appropriate safety clothing when handling damaged batteries.
- Place damaged batteries in an acid-resistant receptacle immediately after removing them.
- Only ever transport damaged batteries in an appropriate acid-resistant receptacle.
- Wash all objects that have come into contact with acid with lots of water.

Disposing of dead or damaged batteries correctly

Dead or damaged batteries can be given back to your dealer or directly to Invacare®.

10.2.5.3 Removing the batteries



CAUTION: Risk of fire and burns if battery poles are bridged!

- *When replacing the batteries the battery poles MUST NOT come into contact with metal parts of the wheelchair causing bridging.*
 - *Be sure to replace the battery pole caps after the batteries have been replaced.*
-

**Pre-requisites:**

- 11 mm open-ended spanner
-
- Remove the battery cover.



- Pull the battery pole caps (1) upward and push back in order to reach the battery poles.
- Use the open-ended spanner to loosen the battery pole clamps.
- Remove the batteries to the rear.

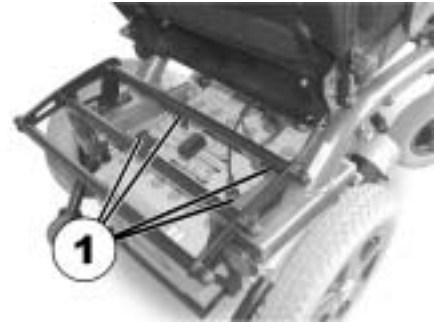

11 Care and maintenance



NOTE:

Have your vehicle checked once a year by an authorised Invacare® dealer in order to maintain it's driving safety and roadworthiness.

Cleaning the vehicle

When cleaning the vehicle, pay attention to the following points:

- Only use a damp cloth and gentle detergent.
- Do not use any abrasive or scouring liquids.
- Do not subject the electronic components to any direct contact with water.
- Do not use high-pressure cleaning devices.

Disinfection

Spray or wipe disinfection using a tested and recognised product is permitted. A list of the current permitted disinfectants is available from the Robert Koch Institute at <http://www.rki.de>.

Maintenance work	At delivery	Weekly	Monthly
Seat and backrest upholstery:			
- Check for perfect working order.			✓
Breast belt			
- Breast belt must be tight fitting. Check Velcro strip for correct function. Velcro strip may not open by itself.			✓
Side panels and arm support:			
- Are all fixing elements fitted?	✓	✓	
- Can the armrests / side panels be removed and refitted without excessive use of force?		✓	
- Are the armrests secured in their position?		✓	
Legrests:			
- Do the legrests engage perfectly (only in case of removable legrests)?			✓
- Do the adjustment options function properly?			✓
Tyres:			
- Check approved air pressure (please refer to technical data).	✓	✓	
Castor wheel forks / swivel wheels:			
- Swivelling wheels must turn freely.		✓	
- Check tight fork bearing seating (torque 15 Nm +/- 1,5 Nm).			✓
Drive wheels:			
- Check the wheels to ensure that they are tightly seated on the drive shaft.			✓
- Drive wheels must turn without side play.			✓

Maintenance work	At delivery	Weekly	Monthly
Electronics / electrics:			
- Check condition and tight fit of all connecting plugs.			✓
- Have the batteries been fully charged before daily start-up?	Before each journey		
- Are all mountings, bolts tight and secure?			✓
- Are all lightbulbs functioning correctly?	Before each journey		
Cleaning:			
- Carefully clean all parts.	When necessary		

Let your authorised Invacare® specialist dealer check your vehicle once every year to ensure that driving safety and functionality are retained. You can find a complete checklist for the inspection and maintenance work to be carried out in the workshop manual, which can be obtained from Invacare®.

12 Repair instructions

The following are instructions on repairs that can be performed by the user. For the specifications of spare parts please see "**Technical specifications**" on page **108**, or consult the Service Manual, available from Invacare® (in this connection please see the addresses and phone numbers in section "**How can you get in touch with Invacare®?**" on page **3**). In case you require assistance, please contact your Invacare® Dealer.

12.1 Repairing a flat tyre



WARNING: Danger of damage or injury if the vehicle is accidentally set into motion during repairs!

- *Switch the power off (ON/OFF Button)!*
 - *Engage the motors!*
 - *Secure the vehicle against rolling away by placing wedges under the wheels!*
-

12.1.1 Repairing a flat tyre at the back (tyre type 3.00-8")



Injury hazard! If the wheel has been insufficiently secured during assembly, it can become loosened during driving!

- *When refitting the drive wheels, tighten the Torx screw that secures the wheel to the hub to a torque of 30 Nm!*
 - *Secure all screws using a suitable threadlock (e.g. Loctite 243)!*
-



Requirements:

- Torque wrench with ...
 - Allen bit 5 mm
 - Torx bit T40
 - Repair kit for tyre repair **or** a new inner tube.
 - Talcum powder
 - Threadlock Loctite (e.g. Loctite 243)
-

Removing the wheel

- Jack the vehicle up and place a block of wood underneath it to prop it up.
- Remove the countersunk screw (1) using the Torx bit.
- Remove the wheel from the axle.



EXPLOSION HAZARD! The wheel will explode if the air pressure is not released from the tyre before disassembling the wheel rim!

- *Always make sure to completely release the air pressure by pressing the pin in the centre of the valve!*

Repairing the flat tyre

- Remove the valve cap.
- Let the air out of the tyre completely by pressing the pin in the centre of the valve in.
- Remove the 5 cylinder head screws (back of the wheel, 2).
- Remove the rim halves from the tyre.
- Remove the inner tube from the tyre.
- Repair the inner tube and re-fit, or replace it with a new one.

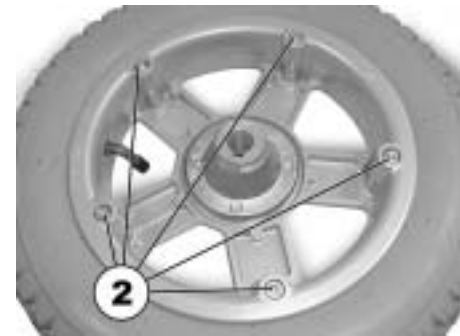



NOTE

In case the old inner tube is to be repaired and used again, and it happens to get wet during repair, then it is easier to re-fit it if you powder it lightly with talcum powder.



NOTE

Re-assembly is done in reverse order. Make sure that the wheel is put back on the same side it was on, and that it runs in the same direction it did before it was removed.

- Re-fit the rim halves back into the tyre.
- Pump up the tyre a little.
- Insert the cylinder head screws in the rim and tighten to 10 Nm. Make sure the inner tube does not get pinched between the rims halves!
- Check to make sure that the tyre is squarely in place on the rim.
- Pump up the tyre to the recommended tyre pressure.
- Check to make sure that the tyre is still squarely and snugly in place on the rim.
- Screw the valve cap back on.
- Refit the wheel.
- Refit the Torx screw using threadlock and tighten to 30 Nm.

13 Transport



CAUTION: Injury hazard or material damage if a power wheelchair which is fitted with a table is transported in a vehicle!

- *If a table is fitted, always remove it before transporting the wheelchair.*



13.1 Transferring the wheelchair to a vehicle



WARNING: The wheelchair is in danger of tipping over if it is transferred to a vehicle while the driver is still seated in the wheelchair!

- *Transfer the wheelchair without the driver whenever possible!*
- *If the wheelchair with the driver has to be transferred to a vehicle using a ramp, ensure that the ramp does not exceed the maximum safe slope (see chapter "**Technical specifications**" starting on page 108)!*
- *If the wheelchair has to be transferred to a vehicle using a ramp that does exceed the maximum safe slope (see chapter "**Technical specifications**" starting on page 108), a winch must then be used! An attendant can then safely monitor and assist the transfer process!*
- *Alternatively, a platform lift may be used!*
- *Ensure that the total weight of the power wheelchair including the user does not exceed the maximum permitted total weight for the ramp or platform lift!*
- *The wheelchair should always be transferred to a vehicle with the backrest in an upright position, the seat lifter lowered and the seat tilt in the upright position (see chapter "**Driving up and down gradients**" on page 39)!*

- Drive or push your wheelchair into the transport vehicle using a suitable ramp.

13.2 Securing the wheelchair for transport without passengers



CAUTION: Injury hazard!

- *If you are unable to fasten your electric wheelchair securely in a transport vehicle, Invacare® recommends that you do not transport it!*
-

- Before transporting your wheelchair, make sure the motors are engaged and that the Joystick Box is switched off.

Invacare® strongly recommends that you additionally disconnect or remove the batteries. See "Removing the batteries" on page 96.

- Invacare® strongly recommends securing the wheelchair to the floor of the transporting vehicle.

14 Refurbishment

The product is suitable for refurbishment. Actions to be carried out:

- Cleaning and disinfection. Please see chapter "Care and maintenance" on page **98**.
- Inspection according to service plan. Please consult service instructions, available from Invacare®.
- Adaptation to the user. Please see chapter "Adjusting the wheelchair to the user's seating posture" on page **43**.

15 Disposal

- The equipment wrapping is potentially recyclable.
- The metal parts are used for scrap metal recycling.
- The plastic parts are used for plastic recycling.
- Electric components and printed circuit boards are disposed of as electronic scrap.
- Exhausted or damaged batteries can be returned to your medical equipment supplier or Invacare®.
- Disposal must be carried out in accordance with the respective national legal provisions.
- Ask your city or district council for details of the local waste management companies.

16 Technical specifications

The technical information provided hereafter applies to a standard configuration or represents maximum achievable values. These can change if accessories are added. The precise changes to these values are detailed in the sections for the respective accessories.

Electric system	
Motors	<ul style="list-style-type: none"> • 2 x 180 W
Batteries	<ul style="list-style-type: none"> • 2 x 12 V/60 Ah (C20) leakproof/gel
Main fuse	<ul style="list-style-type: none"> • 40 A

Charging device	
Output current	<ul style="list-style-type: none"> • 8A ± 8 %
Output voltage	<ul style="list-style-type: none"> • 24 V nominal (12 cells)
Input voltage	<ul style="list-style-type: none"> • 200 – 250 V nominal
Operating temperature (environment)	<ul style="list-style-type: none"> • -25° ... +50 °C
Storing temperature	<ul style="list-style-type: none"> • -40° ... +65 °C

Drive wheel tyres	
Tyre type	<ul style="list-style-type: none"> • 317 (12½" x 2¼") pneumatic or puncture-proof
Tyre pressure	The recommended maximum tyre pressure in bar or kpa is marked on the side wall of the tyre or the rim. If more than one value is listed, the lower one in the corresponding units applies. (Tolerance = -0.3 bar, 1 bar = 100 kpa)

Castor wheel tyres	
Tyre type	<ul style="list-style-type: none"> • 220x50 (9") puncture-proof

Driving qualities	
Speed	<ul style="list-style-type: none"> • 6 km/h
Min. braking distance	<ul style="list-style-type: none"> • 1000 mm
Max. safe slope *****	
Verticalizer completely lowered	<ul style="list-style-type: none"> • 7,9° (13,9 %) according to manufacturer's specifications with 100 kg payload, 4° seat angle, 20° backrest angle
Verticalizer raised	<ul style="list-style-type: none"> • 0° (0 %) according to manufacturer's specifications with 100 kg payload, 4° seat angle, 20° backrest angle
Max. climbable obstacle height	<ul style="list-style-type: none"> • Verticalizer lowered completely: 40 mm • Verticalizer raised: 0 mm
Turning diameter	<ul style="list-style-type: none"> • 1660 mm
Range according to ISO 7176-4:2008 ***	<ul style="list-style-type: none"> • 25 km

Dimensions	
Overall height	<ul style="list-style-type: none"> • 1160 mm
Width of the drive unit	<ul style="list-style-type: none"> • 610 mm
Overall width of the seat (with armrests)	<ul style="list-style-type: none"> • 625 mm
Overall length (incl. legrest)	<ul style="list-style-type: none"> • 1050 mm
Seat height****	<ul style="list-style-type: none"> • 500/550 mm
Seat width (adjustable range of the side sections in brackets)	<ul style="list-style-type: none"> • 410 mm (385 ... 460 mm**)
Clear internal dimension between the arm pads	<ul style="list-style-type: none"> • 450 mm
Seat depth	<ul style="list-style-type: none"> • 380 ... 460 mm
Backrest height ****	<ul style="list-style-type: none"> • 600/650 mm
Seat cushion thickness	<ul style="list-style-type: none"> • 50 mm
Backrest angle (electric)	<ul style="list-style-type: none"> • +6 ... +22°

Dimensions	
Height of armrest	<ul style="list-style-type: none"> • 260 ... 350 mm
Length of legrest	<ul style="list-style-type: none"> • 310 ... 450 mm

Weight	
Kerb weight ****	<ul style="list-style-type: none"> • 131 kg

Component weights	
Batteries	<ul style="list-style-type: none"> • approx. 20 kg per battery

Payload	
Max. payload	<ul style="list-style-type: none"> • 100 kg

** Width can be adjusted via side section adjustment.

*** Note: the range of an electric wheelchair is strongly dependent on external factors such as charge state of the batteries, ambient temperature, local topography, condition of the road surface, tyre pressure, weight of the driver, manner of driving and the use of the batteries for lighting, servos etc.

The specified values are theoretical maximum achievable values measured according to ISO 7176-4:2008.

**** Measured without seat cushion

***** The actual kerb weight depends on the fittings your mobility aid has been supplied with. Every Invacare® mobility aid is weighed when leaving the works. Please refer to the nameplate for the kerb weight (including batteries) measured.

***** Static stability according to ISO 7176-1 = 9° (15,8 %)
Dynamic stability according to ISO 7176-2 = 6° (10,5 %)

17 Inspections Performed

It is confirmed by stamp and signature that all jobs listed in the inspection schedule of the Service and Repair Instructions have been properly performed. The list of the inspection jobs to be performed can be found in the Service Manual which is available through Invacare®.

<u>Delivery Inspection</u>	<u>1st Annual Inspection</u>
Stamp of authorised Dealer / Date / Signature	Stamp of authorised Dealer / Date / Signature
<u>2nd Annual Inspection</u>	<u>3rd Annual Inspection</u>
Stamp of authorised Dealer / Date / Signature	Stamp of authorised Dealer / Date / Signature
<u>4th Annual Inspection</u>	<u>5th Annual Inspection</u>
Stamp of authorised Dealer / Date / Signature	Stamp of authorised Dealer / Date / Signature

Order No. of this Manual: 1451170.DOC
Release Date: 2012-06-29

English